

**Industry thinnest\* multi-sensor cameras with AI Engine** \*the thinnest : i-PRO own research as of February 2022

## 4x4MP(16MP) Outdoor Multi-Sensor Network Camera with AI Engine

i-PRO releases 8 the industry thinnest multi-sensor cameras with AI Engine with lineup of 4MP/6MP/4K, 3eyes/4eyes. It is installed AI analytics applications which identify people and vehicles automatically, and users are able to start the latest surveillance technologies easily. It is designed to reduce installation time(thin and light weight) and continuous view assistance provides you 360/270-degree continuous images.

### Key features

- The thinnest multi-sensor camera (3.5 inches/90 mm)
  - It can be fitted in not only outside, but it also is fitted in inside the facility.
  - (Low profile/Blends in seamlessly with environment)
  - Even though it is rated IK10, it achieves the light weight body.
- A variety kinds of AI Apps selection
  - It can install and use up to 4 different types of AI Apps all together. Using AI processor which identifies object as people or vehicle, it will reduce false alarm compared to conventional model. As result, it can be used many industries.
- Easy installation
  - Just 1 LAN cable covers 4 directions.
  - Thin and hook architecture make easy installation
  - Continuous view assistance by using smartphone navigates you the best angle position.
  - You can change angle by using motorized zoom after installation.\*4MP model only
- High security
  - New multi-sensor camera has equipped FIPS 140-2 level3 certified hardware to upgrade its security standard. Combining pre-installing digital certificates issued by a third party organization(Global Sign) and this, we can declare i-PRO high security level to those who cares cyber security.

### Key i-PRO Spec.

- 4 x 4MP(16MP) 2688x1520 up to 30fps
- 360° coverage with one IP address
- Intelligent Auto (with AI Engine)
- Super Dynamic 108dB
- Color night vision (0.21 to 0.3 lx)
- Smart Coding (with AI Engine)
- Remote zoom and focus
- Continuous view assistance
- Wide range tilt angle adjustment mechanism
- ONVIF® Profile G / M / S / T
  - \*ONVIF is a trademark of ONVIF, Inc.
- FIPS 140-2 level3 certified

### Industry examples

- Public safety (City / Highway toll / Parking gate)
- Transportation (Airport / Train / Subway)
- Education
- Retail



WV-S8544



WV-S8544G



## Specifications

<b>Camera</b>	Image Sensor	4x 1/2.7 type CMOS image sensor
	Minimum Illumination	Color : 0.21 lx (-G: 0.59 lx) {30IRE, F1.44, 1/30 s} <sup>1</sup> Color : 0.3 lx (-G: 0.85 lx) {50IRE, F1.44, 1/30 s} BW : 0.12 lx (-G: 0.34 lx) {50IRE, F1.44, 1/30 s}
	White Balance	ATW1 / ATW2 / AWC
	Maximum shutter	30 fps mode: Max.1/10000s to Max.16/30s 25 fps mode: Max.1/10000s to Max.16/25s
	Intelligent Auto	On / Off
	Super Dynamic	On / Off, The level can be set in the range of 0 to 31.
	Dynamic Range	Max. 108 dB(Super Dynamic: On, Level: 31)
	Adaptive Black Stretch	The level can be set in the range of 0 to 255.
	Back light compensation / High light compensation	BLC (Back light compensation) / HLC (High light compensation) / Off (only when Super dynamic / Intelligent Auto : Off)
	Fog compensation	On / Off (only when Intelligent auto / auto contrast adjust : Off)
	Maximum gain (AGC)	The level can be set in the range of 0 to 11.
	Color/BW (ICR)	Off / On / Auto1(Normal) / Auto2(IR Light) / Auto3(SCC)
	IR LED Light	—
	Digital Noise Reduction	The level can be set in the range of 0 to 255.
	Panorama	Panorama mode (H: 180 deg.)
	Video Motion Detection (VMD)	On / Off, 4 areas available
	Scene Change Detection (SCD)	On / Off, 1 areas available
	Audio Detection	On / Off
	AI Sound Classification	Selectable from Gunshot, Yell, Vehicle horn, Glass break
	AI Analytics	Yes
Privacy Zone	On / Off, Up to 8 zones available	
VIQS	On / Off, Up to 8 zones available	
Image rotation <sup>2</sup>	0° (Off) / 90° / 180° (Upside-down) / 270°	
Camera Title (OSD)	On / Off, Up to 40 characters, Up to 2 Lines (alphanumeric characters, marks)	
Focus Adjustment	Auto focus	
<b>Lens</b>	Optical zoom	2.5x (Motorized zoom / Motorized focus)
	Extra zoom	max 10.5x (2.5x - 10.5x when resolution is 640x360)
	Focal length	2.9 mm(1/8 inches) - 7.3 mm(1/4 inches)
	Angular Field of View	Horizontal: 43° (TELE) - 100° (WIDE), Vertical: 24° (TELE) - 56° (WIDE)
	Maximum Aperture Ratio	1: 2.0(WIDE) - 1: 3.0(TELE)
	Focus range	1 m (3.28 ft) - ∞
<b>DORI</b>	Detect (25ppm / 8ppf)	Wide : 45.1 m / 148.0 ft, Tele : 147.7 m / 484.6 ft
	Observe (62.5ppm / 19ppf)	Wide : 18.0 m / 59.2 ft, Tele : 59.1 m / 193.8 ft
	Recognize (125ppm / 38ppf)	Wide : 9.0 m / 29.6 ft, Tele : 29.5 m / 96.9 ft
	Identify (250ppm / 76ppf)	Wide : 4.5 m / 14.8 ft, Tele : 14.8 m / 48.5 ft
<b>System on Chip (SoC)</b>	Ambarella CV2	
<b>Adjusting Angle</b>	Camera 1, 2, 3, 4 :	Horizontal : ±125° (Adjust by horizontal (PAN) angle) Vertical : +10° to +105° (Adjust by vertical (TILT) angle) Yaw : +90° (Adjust by azimuth (YAW) angle) Twist : ±30°
		*The above is the adjustable range of a single camera. The adjustable range of each camera varies according to the positional relationship with other cameras.
<b>Browser GUI</b>	Camera Control	Brightness, AUX On / Off
	Audio	Mic (Line) Input : On / Off Volume adjustment : Low / Middle / High Audio Output : On / Off Volume adjustment : Low / Middle / High
	GUI / Setup Menu Language Browser <sup>3</sup>	English, Italian, French, German, Spanish, Portuguese, Russian, Chinese, Japanese Microsoft Edge, Firefox, Google Chrome
<b>Network</b>	Network IF	10Base-T / 100Base-TX / 1000Base-T, RJ45 connector
	Resolution	<b>[16 : 9 mode]</b> 2688 x 1520 / 2560 x 1440 / 1920x1080 / 1280 x 720 / 640x360 / 320x180
	H.265 / H.264 / JPEG (MJPEG)	Constant bit rate / VBR / Frame rate / Best effort
	H.265 / H.264 <sup>4</sup>	Unicast port (AUTO) / Unicast port (MANUAL) / Multicast
	JPEG	Image Quality 10 steps

<b>Network</b>	Smart Coding	<b>GOP (Group of pictures) control :</b> On (Frame rate control) * / On (Advanced) * / On (Mid) / On (Low) / Off * *On (Frame rate control) and On (Advanced) are only available with H.265. <b>Smart VIQS:</b> On(High)/On(Low)/Off, <b>Smart P-picture control:</b> On/Off
	Audio Compression	G.726 (ADPCM) : 16 kbps / 32 kbps G.711 : 64 kbps AAC-LC <sup>5</sup> : 64 kbps / 96 kbps / 128 kbps
	Audio transmission mode	Off / Mic (Line) input / Audio output / Interactive (Half duplex) / Interactive (Full duplex)
	Supported Protocol	IPv6 : TCP/IP, UDP/IP, HTTP, HTTPS, SSL/TLS, SMTP, DNS, NTP, SNMPv1/v2/v3, DHCPv6, RTP, MLD, ICMP, ARP, IEEE 802.1X, DiffServ, LLDP, MQTT IPv4 : TCP/IP, UDP/IP, HTTP, HTTPS, SSL/TLS, RTP, RTSP, RTCP, SMTP, DHCP, DNS, DDNS, NTP, SNMPv1/v2/v3, UPnP, IGMP, ICMP, ARP, IEEE 802.1X, DiffServ, SRTP, LLDP, MQTT
	No. of Simultaneous Users	Up to 24 users (Depends on network conditions)
	Secure	FIPS 140-2 level3
	SDXC/SDHC/SD Memory Card	H.265 / H.264 recording : Manual REC / Alarm REC (Pre/Post) / Schedule REC / Backup upon network failure JPEG recording : Manual REC / Alarm REC (Pre/Post) / Backup upon network failure Compatible SDXC/SDHC/SD Memory Card : microSDXC memory card : 64 GB, 128 GB, 256 GB, 512 GB microSDHC memory card : 4 GB, 8 GB, 16 GB, 32 GB microSD memory card : 2 GB
	Mobile Terminal Compatibility	iPad, iPhone, Android™ terminals
	ONVIF® Profile	G / M / S / T
	<b>Alarm</b>	Alarm Source
Alarm Actions		SDXC/SDHC/SD memory recording, E-mail notification, HTTP alarm notification indication on browser, TCP alarm notification output
<b>Input/ Output</b>	Monitor Output (for adjustment)	—
	Audio input <sup>6</sup>	ø3.5 mm stereo mini jack For microphone input : Recommended applicable microphone : Plug-in power type (Sensitivity of microphone : -48 dB±3 dB (0 dB=1 V/Pa, 1 kHz)) Input impedance : Approx. 2 kΩ (unbalanced) Supply voltage : 2.4 V ±0.5 V For line input : Input level : Approx. -10 dBV
	Audio Output <sup>6</sup>	ø3.5 mm stereo mini jack (monaural output) Output impedance : Approx. 600 Ω (unbalanced) Output level : -20 dBV
	External I/O Terminals <sup>6</sup>	ALARM IN 1 (Alarm input 1/ Black & white input/ Auto time adjustment input) (x1) ALARM IN 2 (Alarm input 2/ ALARM OUT) (x1), ALARM IN 3 (Alarm input 3/ ALARM OUT/ AUX OUT) (x1)
<b>General</b>	Safety	UL (UL62368-1), c-UL (CSA C22.2 No.62368-1), CE, IEC62368-1
	EMC	FCC (Part15 ClassA), ICES-003 ClassA, EN55032 ClassA, EN55024
	Power Source and Power Consumption	PoE+ (IEEE802.3at compliant): DC 54 V : 320 mA/Approx. 17.3 W (Class 4 device)
	Ambient Operating Temperature	-40 °C to +60 °C (-40 °F to 140 °F) (Power On range: -20 °C to +60 °C [-4 °F to 140 °F]) Maximum temperature according to NEMA TS 2 (2.2.7): 74 °C(165 °F)
	Ambient Operating Humidity	10 to 100 % (no condensation)
	Anti-Condensation System	Temish element + Heater + moisture absorption gel
	Water and Dust Resistance	IP67/IP66 (IEC 60529), Type 4X (UL50E), NEMA 4X compliant
	Shock Resistance	IK10 (IEC62262)
	Other standard support	NEMA TS 2 (2.2.7-2.2.9)
	Dimensions	When using the attachment plate only : ø300 mm × 90 mm (H) {ø11-13/16 inches × 3-17/32 inches (H)}
Mass (approx.)	When using the attachment plate only : Approx. 3.3 kg (7.28 lbs)	
Finish	Main body : Aluminum die cast, i-PRO white Outer fixing screws : Stainless steel (Corrosion-resistant treatment) Dome cover : PC resin, Clear PC resin, Smoke (G)	

<sup>1</sup> Converted value

<sup>2</sup> When the 320x180 resolution is used, the "90°" and "270°" settings are not available.

<sup>3</sup> For information on the operation verification of the supported web browsers, refer to our support website <Control No. : C0132>.

<sup>4</sup> Transmission for each stream can be individually set.

<sup>5</sup> When recording audio on an microSD memory card, only use AAC-LC (Advanced Audio Coding - Low Complexity).

<sup>6</sup> When using with these, WV-QCA501A cable is required.

## Appearance

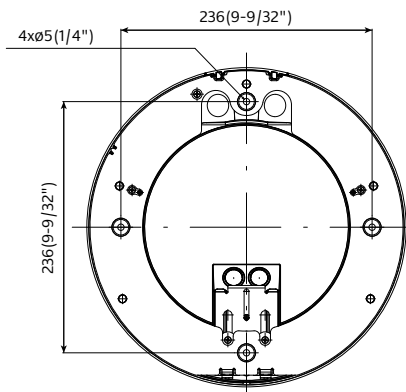
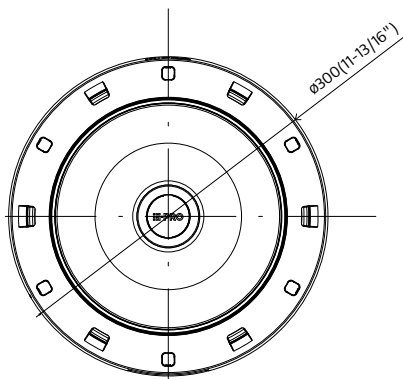
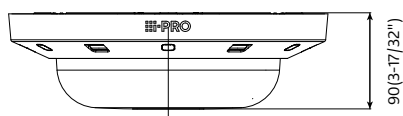

Unit : mm (inches)

## AI Analytics applications

<https://i-pro.com/global/en/surveillance/products/i-pro-ai-application>

### AI Video Motion Detection (AI-VMD)

Advanced video analysis technology detects objects (faces, people, cars, motorcycles) in a specified area. (Intruder Detection, Loitering Detection, Direction Detection, Cross Line Detection)

### AI Face Detection

Detects faces with high precision even in low-light, backlit, and mask-wearing environments. (Max. 2 cameras working)

### AI People Detection

Extract the characteristics of human face / clothing and classify them into meaningful categories such as gender, age, and clothing color.

### AI Vehicle Detection

Extract vehicle characteristics and classify them into meaningful categories such as type and color.

### AI Non mask Detection

Deep-learning and proprietary image processing technologies recognize mask and detect people who are not wearing them.

### AI Occupancy Detection

















Detecting the congestion via network camera with AI engine enables that information to be used direct visitors in advance or help store staff work more efficiently.

3rd party applications are also available.



<https://i-pro.com/global/en/surveillance/i-pro-application-platform/application-list>

## Optional Accessories

### Mount Bracket / Other

	WALL		POLE		CORNER		HANGING			CEILING	
	1	1	1	1	1	1	2	3	1	2	
combination	<b>Wall Mount Bracket</b> <b>WV-QWL501-W</b> (i-PRO white) 	<b>Pole Mount Bracket</b> <b>WV-QPL500-W</b> (i-PRO white) 	<b>Corner Mount Bracket</b> <b>WV-QCN500-W</b> (i-PRO white) 	<b>Ceiling Mount Bracket</b> <b>WV-QCL501-W</b> (i-PRO white) 	<b>Ceiling Mount Bracket</b> <b>WV-QCL100-W</b> (i-PRO white)  *For indoor installation only.	<b>Ceiling Mount Bracket</b> <b>WV-QCL100-W*1</b> (i-PRO white)  *For indoor installation only.	<b>Base Bracket</b> <b>WV-QJB503-W</b> (i-PRO white)  *The actual product may differ.	<b>Ceiling Mount Bracket</b> <b>WV-Q105A</b> (Silver)  *For indoor installation only.			
	<b>Mount Bracket</b> <b>WV-QSR503-W</b> (i-PRO white) 	<b>Wall Mount Bracket</b> <b>WV-QWL501-W</b> (i-PRO white) 	<b>Wall Mount Bracket</b> <b>WV-QWL501-W</b> (i-PRO white) 	<b>Mount Bracket</b> <b>WV-QSR503-W</b> (i-PRO white) 	<b>Mount Bracket</b> <b>WV-QSR503M-W</b> (i-PRO white, ISO Male thread) 	3rd Party Pipe (i-PRO white, ISO Male thread)		<b>Base Bracket</b> <b>WV-QJB503-W</b> (i-PRO white)  *The actual product may differ.			
		<b>Mount Bracket</b> <b>WV-QSR503-W</b> (i-PRO white) 	<b>Mount Bracket</b> <b>WV-QSR503-W</b> (i-PRO white) 			<b>Mount Bracket</b> <b>WV-QSR503F-W</b> (i-PRO white, ISO Female thread) 					

\*1: It's possible to be used on the camera side and ceiling side. If used on both side, 2pieces are required.

OTHER	
1	
3rd Party Pipe (Male or Female thread)	
<b>Mount Bracket</b> <b>WV-QSR503F-W</b> (i-PRO white, ISO Female thread) 	
<b>Mount Bracket</b> <b>WV-QSR503M-W</b> (i-PRO white, ISO Male thread) 	

### Dome Cover

Smoke dome cover  
**WV-QDC501G**

### Cable

I/O Cable  
**WV-QCA501A**  
**WV-QCA501APK**



\*WV-QCA501APK is package of 10 cables.

\*The color of the grommet rubber may differ depending on the production time, but the performance and mounting method will not change.

### Trademarks and registered trademarks

- iPad and iPhone are trademarks of Apple Inc., registered in the U.S. and other countries.
- Android is a trademark of Google LLC.
- ONVIF is a trademark of ONVIF, Inc.
- All other trademarks identified herein are the property of their respective owners.

### Important

- Safety Precautions : Carefully read the Basic Information, Installation Guide and Operating Instructions before using this product.
- i-PRO Co., Ltd. cannot be held responsible for the performance of the network and/or other manufacturers' products used on the network.

• Masses and dimensions are approximate. • Specifications are subject to change without notice.