

New U-series compact network camera with enhanced functions and affordability

4MP Varifocal Lens Outdoor Bullet Network Camera

The new U series is an entry model that achieves high quality and reliability at an affordable price to meet the needs of a wide range of customers. The compact and slim design allows it to be installed in a various locations.

It newly supports ONVIF G / S / T profile and H.265 / H.264, and can be widely used for connecting various VMS and recorders. It also comes pre-installed with secure certificates, enabling device authentication and end-to-end communication encryption to counter the threat of advanced cyberattacks.

Key features

- Compact and slim design allows installation in various locations
- Compliant with ONVIF G / S / T profile and H.265 / H.264, and can support a wide range of connections to VMS and recorders
- Uses "Easy Kitting Packing" that allows you to set the camera without removing it from the box
- Strengthen cyber security by pre-installing digital certificates issued by a third party organization (GlobalSign)

Key i-PRO Spec.

- 5MP Sensor
- 2688×1520 pixel image up to 30fps
- 2.5x built-in motorized zoom and motorized focus lens
- iA (intelligent Auto)
- Super Dynamic 102dB
- Color night vision (0.019 to 0.3 lx)
- H.265 Smart Coding
- Corridor mode
(90 degrees or 270 degrees in image rotation)
- Built-in IR LED
- ONVIF® Profile G / S / T
*ONVIF is a trademark of ONVIF, Inc.
- Genetec Stratocast compatible

Industry examples

- Public safety (City / Highway toll / Parking gate)
- Transportation (Airport / Train / Subway)
- Retail / Bank / Logistics / Education / Hospital / Building



Specifications

Camera	Image Sensor	Approx. 1/2.7 type CMOS image sensor
	Minimum Illumination	Color : 0.3 lx, BW: 0.12 lx (50IRE, F2.0, Maximum shutter: Off (1/30s), AGC: 11) BW : 0 lx (0 footcandle) (50IRE, F2.0, Maximum shutter: Off (1/30 s), AGC: 11, when the IR LED is lit) Color : 0.019 lx, BW: 0.0075 lx (50IRE, F2.0, Maximum shutter: max. 16/30s, AGC: 11) ^{*1}
	White Balance	ATW1/ ATW2/ AWC
	Maximum shutter	[30fps mode] Max. 1/10000 s to Max. 16/30 s [25fps mode] Max. 1/10000 s to Max. 16/25 s
	Intelligent Auto	On / Off
	Super Dynamic	On / Off, The level can be set in the range of 0 to 31.
	Dynamic Range	Max.102 dB (Super Dynamic: On, Level: 31)
	Adaptive Black Stretch	—
	Back light compensation / High light compensation	BLC/ HLC/ Off (only when Super Dynamic/ Intelligent auto: Off)
	Fog compensation	On / Off, The level can be set in the range of 0 to 8. (only when intelligent auto / auto contrast adjust: Off)
	Maximum gain (AGC)	The level can be set in the range of 0 to 11.
	Color/BW (ICR)	Off/ On (IR Light Off) / On (IR Light On) / Auto1 (IR Light Off) / Auto2 (IR Light On) / Auto3 (SCC)
	IR LED Light	High/ Middle/ Low/ Off Maximum irradiation distance: 20 m (Approx. 65 ft)
	Digital Noise Reduction	The level can be set in the range of 0 to 255.
	Video Motion Detection (VMD)	On / Off, 4 areas available
	Scene Change Detection(SCD)	On / Off, 1 areas available
	Privacy Zone	On / Off, Up to 8 zones available
	Image rotation	0° (Off) / 90° / 180° (Upside-down) / 270°
Camera Title (OSD)	On / Off, Up to 20 characters (alphanumeric characters, marks)	
Lens	Focal length	2.9 mm - 7.3 mm (1/8inches-9/32inches)
	Optical zoom	2.5x (Motorized zoom / Motorized focus)
	Extra optical zoom	2.5x - 3.3x (when resolution is 1920x1080)
	Digital (electronic) zoom	Choose from 3 levels of x1, x2, x4
	Angular Field of View	[16 : 9 mode] * [4:3 mode] is not supported. Horizontal : 44° (TELE) - 103° (WIDE), Vertical : 25° (TELE) - 57° (WIDE)
	Maximum Aperture Ratio	1 : 2.0 (WIDE) - 1 : 3.0 (TELE)
Focus range	1 m (39-3/8 inches) - ∞	
DORI	Detect (25ppm / 8ppf)	Wide: 40.7 m / 133.6 ft, Tele: 126.7 m / 415.8 ft
	Observe (62.5ppm / 19ppf)	Wide: 16.3 m / 53.4 ft, Tele: 50.7 m / 166.3 ft
	Recognize (125ppm / 38ppf)	Wide: 8.1 m / 26.7 ft, Tele: 25.3 m / 83.2 ft
	Identify (250ppm / 76ppf)	Wide: 4.1 m / 13.4 ft, Tele: 12.7 m / 41.6 ft
Adjusting Angle	Ceiling mounting	Horizontal: ±180° (Adjust by horizontal (PAN) angle) Vertical : 0° to 100° (Adjust by vertical (TILT) angle) Yaw : -190° to +100° (Adjust by azimuth (YAW) angle)
	Wall mounting	Horizontal: ±100° (Adjust by vertical (TILT) angle)* Vertical : ±100° (Adjust by vertical (TILT) angle)* Yaw : -190° to +100° (Adjust by azimuth (YAW) angle) *You can change between horizontal and vertical angles by adjusting the horizontal (PAN) angle.
Browser GUI	Camera Control	Brightness
	GUI / Setup Menu Language	English, Italian, French, German, Spanish, Portuguese, Russian, Chinese, Japanese

*1 Converted value

*2 Smart Coding (GOP and AUTO VIQS) is not available when setting 30fps.

*3 It may be necessary to upgrade the firmware to use these protocols.

*4 Only when installation work is properly performed according to the Installation Guide and appropriate waterproof treatment is performed.

Network	Network IF	10Base-T / 100Base-TX, RJ45 connector				
	Resolution	[16:9 mode(2688x1520 30fps mode)], [16:9 mode(2688x1520 25fps mode)] 2688x1520, 1920x1080, 640x360, 320x180 [16:9 mode(30fps mode)], [16:9 mode(25fps mode)] 2560x1440, 1920x1080, 640x360, 320x180 * [4:3 mode] is not supported.				
	H.265 / H.264	Transmission Mode	Constant bit rate / VBR / Frame rate / Best effort			
		Transmission Type	Unicast / Multicast			
		Max. frame rate for each stream*2	Stream (1)	Stream (2)	Stream (3)	JPEG (1)
			2688x1520(30fps)	Off	Off	2560x1440(1fps)
			2560x1440(30fps)	640x360(30fps)	Off	2560x1440(1fps)
			1920x1080(30fps)	1920x1080(30fps)	640x360(10fps)	1920x1080(1fps)
	JPEG	Image Quality	10 steps			
		Smart Coding	GOP(Group of pictures) control: On(Frame rate control) / On(Advanced) / On(Mid) / On(Low) / Off *Frame rate control and Advanced are only available with H.265. AUTO VIQS: On/ Off			
	Audio Compression	—				
	Audio transmission mode	—				
	Supported Protocol	IPv6 : TCP/IP, UDP/IP, HTTP, HTTPS, SSL/TLS, SMTP, DNS, NTP, SNMPv1/v2/v3, DHCPv6, RTP, MLD, ICMP, ARP, IEEE 802.1X, DiffServ, MQTT ³ , LLDP ³ IPv4 : TCP/IP, UDP/IP, HTTP, HTTPS, SSL/TLS, RTSP, RTP, RTCP, SMTP, DHCP, DNS, DDNS, NTP, SNMPv1/v2/v3, UPnP, IGMP, ICMP, ARP, IEEE 802.1X, DiffServ, MQTT ³ , LLDP ³				
	No. of Simultaneous Users	Up to 14 users (Depends on network conditions)				
	SDXC/SDHC/SD Memory Card	H.265/H.264 recording: Manual REC / Alarm REC (Pre/Post) / Schedule REC Compatible SDXC/SDHC/SD Memory Card : microSDXC memory card: 64 GB, 128 GB, 256 GB, 512 GB microSDHC memory card: 4 GB, 8 GB, 16 GB, 32 GB microSD memory card: 2 GB				
	Mobile Terminal Compatibility	iPad, iPhone, Android™ terminals				
	ONVIF® Profile	G / S / T				
Alarm	Alarm Source	VMD alarm, SCD alarm, Command alarm				
	Alarm Actions	SDXC/SDHC/SD memory recording, E-mail notification, HTTP alarm notification indication on browser, TCP alarm notification output				
Input/ Output	Monitor Output(for adjustment)	—				
	Audio input	—				
	Audio Output	—				
	External I/O Terminals	—				
General	Safety	UL (UL60950-1), c-UL (CSA C22.2 No.60950-1), CE, IEC60950-1				
	EMC	FCC (Part15 ClassA), ICES003 ClassA, EN55032 ClassB, EN55024				
	Power Source and Power Consumption	PoE (IEEE802.3af compliant) Device: DC48 V 150 mA, Approx. 7.2 W (Class 0 device)				
	Ambient Operating Temperature	-30 °C to +50 °C (-22 °F to +122 °F) {Power On range: -20 °C to +50 °C (-4 °F to +122 °F)}				
	Ambient Operating Humidity	10 to 100 % (no condensation)				
	Anti-Condensation System	Temish element				
	Water and Dust Resistance ⁴	IP66 (IEC 60529), Type 4X (UL50E), NEMA 4X compliant				
	Shock Resistance	IK10 (IEC 62262)				
	Dimensions	112.5 mm (W) x 112.5 mm (H) x 262 mm (D) {4-7/16 inches(W) x 4-7/16 inches(H) x 10-5/16 inches(D)}				
	Mass (approx.)	860 g (1.90 lbs.)				
	Finish	Main body: Aluminum die cast/ PC resin, i-PRO white Outer fixing screws: Stainless steel (Corrosion-resistant treatment) Front cover: Polycarbonate resin, Clear				

Appearance



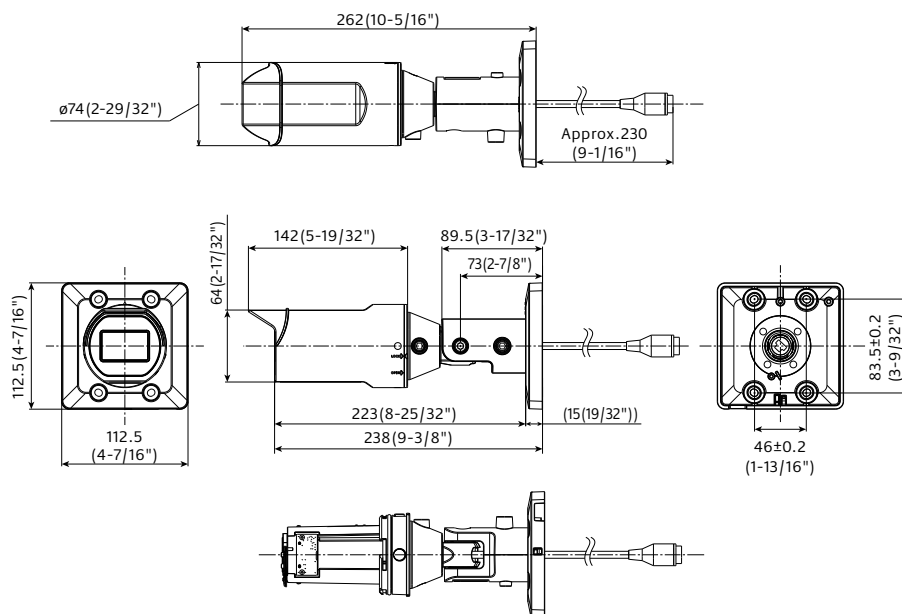



Unit : mm (inches)



Without front cover

Optional Accessories

Mount Bracket / Other

	WALL/CEILING	POLE	CORNER	HANGING
combination	1 Adapter Box WV-QJB500-W (i-PRO white)  *If needed.	1 Pole Mount Bracket WV-QPL500-W (i-PRO white) 	1 Corner Mount Bracket WV-QCN500-W (i-PRO white) 	1 Ceiling Mount Bracket WV-QCL100-W ^{*1} (i-PRO white)  *For indoor installation only.
		Adapter Box WV-QJB500-W (i-PRO white)  *If needed.	Adapter Box WV-QJB500-W (i-PRO white)  *If needed.	3rd Parties Pipe

*1 : It's possible to be used on the camera side and ceiling side. If used on both side, 2pieces are required.

Trademarks and registered trademarks

- iPad and iPhone are trademarks of Apple Inc., registered in the U.S. and other countries.
- Android is a trademark of Google LLC.
- ONVIF is a trademark of ONVIF, Inc.
- All other trademarks identified herein are the property of their respective owners.

Important

- Safety Precautions : Carefully read the Basic Information, Installation Guide and Operating Instructions before using this product.
- i-PRO Co., Ltd. cannot be held responsible for the performance of the network and/or other manufacturers' products used on the network.

• Masses and dimensions are approximate. • Specifications are subject to change without notice.