

New U-series compact network camera with enhanced functions and affordability

4MP Varifocal Lens Outdoor Dome Network Camera

The new U series is an entry model that achieves high quality and reliability at an affordable price to meet the needs of a wide range of customers. The compact and slim design allows it to be installed in a various locations.

It newly supports ONVIF G / S / T profile and H.265 / H.264, and can be widely used for connecting various VMS and recorders. It also comes pre-installed with secure certificates, enabling device authentication and end-to-end communication encryption to counter the threat of advanced cyberattacks.

Key features

- Compact and slim design allows installation in various locations
- Compliant with ONVIF G / S / T profile and H.265 / H.264, and can support a wide range of connections to VMS and recorders
- Uses "Easy Kitting Packing" that allows you to set the camera without removing it from the box
- Strengthen cyber security by pre-installing digital certificates issued by a third party organization (GlobalSign)

Key i-PRO Spec.

- 5MP Sensor
- 2688×1520 pixel image up to 30fps
- 2.5x built-in motorized zoom and motorized focus lens
- iA (intelligent Auto)
- Super Dynamic 102dB
- Color night vision (0.019 to 0.3 lx)
- H.265 Smart Coding
- Corridor mode
(90 degrees or 270 degrees in image rotation)
- Built-in IR LED
- ONVIF® Profile G / S / T
*ONVIF is a trademark of ONVIF, Inc.
- Genetec Stratocast compatible

Industry examples

- Safe Cities
- Transportation (Airport / Train, Subway station)
- Bank (ATM, Entrance)
- Retail / Logistics / Education / Hospital / Building



Specifications

Camera	Image Sensor	Approx. 1/2.7 type CMOS image sensor
	Minimum Illumination	Color : 0.3 lx, BW: 0.12 lx (50IRE, F2.0, Maximum shutter: Off (1/30s), AGC: 11) BW : 0 lx (0 footcandle) (50IRE, F2.0, Maximum shutter: Off (1/30 s), AGC: 11, when the IR LED is lit) Color : 0.019 lx, BW: 0.0075 lx (50IRE, F2.0, Maximum shutter: max. 16/30s, AGC: 11)* 1
	White Balance	ATW1/ ATW2/ AWC
	Maximum shutter	[30fps mode] Max. 1/10000 s to Max. 16/30 s [25fps mode] Max. 1/10000 s to Max. 16/25 s
	Intelligent Auto	On / Off
	Super Dynamic	On / Off, The level can be set in the range of 0 to 31.
	Dynamic Range	Max.102 dB (Super Dynamic: On, Level: 31)
	Adaptive Black Stretch	—
	Back light compensation / High light compensation	BLC / HLC / Off (only when Super Dynamic / Intelligent auto: Off)
	Fog compensation	On / Off, The level can be set in the range of 0 to 8. (only when intelligent auto / auto contrast adjust: Off)
	Maximum gain (AGC)	The level can be set in the range of 0 to 11.
	Color/BW (ICR)	Off / On (IR Light Off) / On (IR Light On) / Auto1 (IR Light Off) / Auto2 (IR Light On) / Auto3 (SCC)
	IR LED Light	High/ Middle/ Low/ Off Maximum irradiation distance: 20 m (Approx. 65 ft)
	Digital Noise Reduction	The level can be set in the range of 0 to 255.
	Video Motion Detection (VMD)	On / Off, 4 areas available
	Scene Change Detection(SCD)	On / Off, 1 areas available
	Privacy Zone	On / Off, Up to 8 zones available
	Image rotation	0° (Off) / 90° / 180° (Upside-down) / 270°
	Camera Title (OSD)	On / Off, Up to 20 characters (alphanumeric characters, marks)
	Lens	Focal length
Optical zoom		2.5x (Motorized zoom / Motorized focus)
Extra optical zoom		2.5x - 3.3x (when resolution is 1920x1080)
Digital (electronic) zoom		Choose from 3 levels of x1, x2, x4
Angular Field of View		[16 : 9 mode] * [4:3 mode] is not supported. Horizontal : 43° (TELE) - 100° (WIDE), Vertical : 24° (TELE) - 56° (WIDE)
Maximum Aperture Ratio		1 : 2.0 (WIDE) - 1 : 3.0 (TELE)
Focus range		1 m {39-3/8 inches} - ∞
DORI	Detect (25ppm / 8ppf)	Wide: 43.0 m / 141.0 ft, Tele: 130.0 m / 426.4 ft
	Observe (62.5ppm / 19ppf)	Wide: 17.2 m / 56.4 ft, Tele: 52.0 m / 170.6 ft
	Recognize (125ppm / 38ppf)	Wide: 8.6 m / 28.2 ft, Tele: 26.0 m / 85.3 ft
	Identify (250ppm / 76ppf)	Wide: 4.3 m / 14.1 ft, Tele: 13.0 m / 42.6 ft
Adjusting Angle	Ceiling mounting	—
	Wall mounting	—
Browser GUI	Camera Control	Brightness
	GUI / Setup Menu Language	English, Italian, French, German, Spanish, Portuguese, Russian, Chinese, Japanese

*1 Converted value

*2 Smart Coding (GOP and AUTO VIQS) is not available when setting 30fps.

*3 It may be necessary to upgrade the firmware to use these protocols.

*4 Only when installation work is properly performed according to the Installation Guide and appropriate waterproof treatment is performed.

Network	Network IF	10Base-T / 100Base-TX, RJ45 connector				
	Resolution H.265/H.264	[16:9 mode(2688x1520 30fps mode)], [16:9 mode(2688x1520 25fps mode)] 2688x1520, 1920x1080, 640x360, 320x180 [16:9 mode(30fps mode)], [16:9 mode(25fps mode)] 2560x1440, 1920x1080, 640x360, 320x180 * [4:3 mode] is not supported.				
	H.265/H.264	Transmission Mode	Constant bit rate / VBR / Frame rate / Best effort			
		Transmission Type	Unicast / Multicast			
	Max. frame rate for each stream*2	Stream(1)	Stream(2)	Stream(3)	JPEG(1)	JPEG(2)
		2688x1520(30fps)	Off	Off	2560x1440(1fps)	1920x1080(1fps)
		2560x1440(30fps)	640x360(30fps)	Off	2560x1440(1fps)	1920x1080(1fps)
	JPEG	Image Quality	10 steps			
	Smart Coding	GOP(Group of pictures) control: On(Frame rate control) / On(Advanced) / On(Mid) / On(Low) / Off *Frame rate control and Advanced are only available with H.265. AUTO VIQS: On / Off				
	Audio Compression	—				
Audio transmission mode	—					
Supported Protocol	IPv6 : TCP/IP, UDP/IP, HTTP, HTTPS, SSL/TLS, SMTP, DNS, NTP, SNMPv1/v2/v3, DHCPv6, RTP, MLD, ICMP, ARP, IEEE 802.1X, DiffServ, MQTT*3, LLDP*3 IPv4 : TCP/IP, UDP/IP, HTTP, HTTPS, SSL/TLS, RTSP, RTP, RTPTCP, SMTP, DHCP, DNS, DDNS, NTP, SNMPv1/v2/v3, UPnP, IGMP, ICMP, ARP, IEEE 802.1X, DiffServ, MQTT*3, LLDP*3					
No. of Simultaneous Users	Up to 14 users (Depends on network conditions)					
SDXC/SDHC/SD Memory Card	H.265/H.264 recording: Manual REC / Alarm REC (Pre/Post) / Schedule REC Compatible SDXC/SDHC/SD Memory Card : microSDXC memory card: 64 GB, 128 GB, 256 GB, 512 GB microSDHC memory card: 4 GB, 8 GB, 16 GB, 32 GB microSD memory card: 2 GB					
Mobile Terminal Compatibility	iPad, iPhone, Android™ terminals					
ONVIF® Profile	G / S / T					
Alarm	Alarm Source	VMD alarm, SCD alarm, Command alarm				
	Alarm Actions	SDXC/SDHC/SD memory recording, E-mail notification, HTTP alarm notification Indication on browser, TCP alarm notification output				
Input/Output	Monitor Output(for adjustment)	—				
	Audio input/Audio Output External I/O Terminals	—				
General	Safety	UL (UL60950-1) , c-UL (CSA C22.2 No.60950-1) , CE, IEC60950-1				
	EMC	FCC (Part15 ClassA) , ICES003 ClassA, EN55032 ClassB, EN55024				
	Power Source and Power Consumption	PoE (IEEE802.3af compliant) Device: DC48 V 150 mA, Approx. 7.2 W (Class 0 device)				
	Ambient Operating Temperature	-30 °C to +50 °C (-22 °F to +122 °F) {Power On range: -20 °C to +50 °C (-4 °F to +122 °F)}				
	Ambient Operating Humidity	10 to 100 % (no condensation)				
	Anti-Condensation System	Temish element				
	Water and Dust Resistance*4	IP66 (IEC 60529) , Type 4X (UL50E) , NEMA 4X compliant				
	Shock Resistance	IK10 (IEC 62262)				
	Dimensions	ø154 mm (W) x 103 mm (H) {ø6-1/16 inches x 4-1/16 inches (H)} Dome radius 42 mm {1-21/32 inches}				
	Mass (approx.)	1.0 kg {2.21 lbs.}				
Finish	Main body: Aluminum die cast/ PC resin, i-PRO white Outer fixing screws: Stainless steel (Corrosion-resistant treatment) Dome cover: Polycarbonate resin, Clear					

Appearance

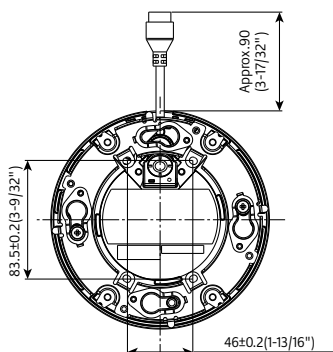
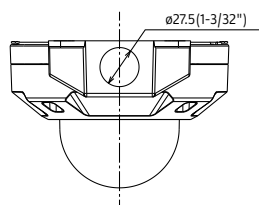
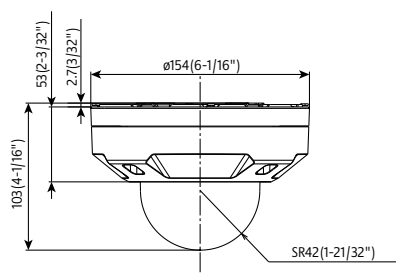

With Attachment plate

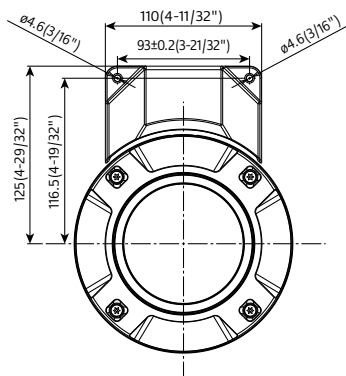



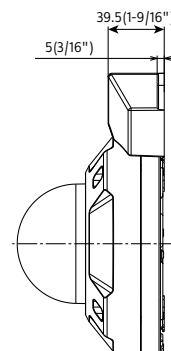









With Attachment for the conduit







Unit : mm (inches)

Optional Accessories

Mount Bracket / Other

combination	WALL			POLE	CORNER	HANGING	
	1	2	3	1	1	1	2
	Wall Mount Bracket WV-QWL501-W (i-PRO white) 	Wall Mount Bracket WV-QWL500-W (i-PRO white) 	Sun Shade WV-QSR500-W (i-PRO white) 	Pole Mount Bracket WV-QPL500-W (i-PRO white) 	Corner Mount Bracket WV-QCN500-W (i-PRO white) 	Ceiling Mount Bracket WV-QCL501-W (i-PRO white) 	Ceiling Mount Bracket WV-QCL100-W *1 (i-PRO white)  <small>*For indoor installation only.</small>
	Mount Bracket WV-QSR501-W (i-PRO white) 	Adapter Box WV-QJB500-W (i-PRO white)  <small>*If needed.</small>	Base Bracket WV-QJB501-W (i-PRO white) 	Wall Mount Bracket WV-QWL500-W (i-PRO white) (+ WV-QJB500-W) 	Wall Mount Bracket WV-QWL500-W (i-PRO white) (+ WV-QJB500-W) 	Mount Bracket WV-QSR501-W (i-PRO white) 	3rd. parties pipe

*1: It's possible to be used on the camera side and ceiling side. If used on both side, 2pieces are required.

combination	CEILING			OTHER
	1	2	3	1
	Ceiling Mount Bracket (Embedded) WV-QEM500-W (i-PRO white) 	Base Bracket WV-QJB501-W (i-PRO white) 	Ceiling Mount Bracket WV-Q105A  <small>*For indoor installation only.</small>	Attachment pipe (For 3rd party bracket) WV-QAT500-W (i-PRO white) 
				Mount Bracket WV-QSR501-W (i-PRO white) 

Dome Cover

Dome Cover (Smoke type) WV-CW7S 	Dome Cover (Smoke type with ClearSight coating) WV-CW7SN 	Dome Cover (Clear type with ClearSight coating) WV-CW7CN 
----------------------------------------------------------------------------------------------------------------------------------	-----------------------------------------------------------------------------------------------------------------------------------------------------------	-----------------------------------------------------------------------------------------------------------------------------------------------------------

Trademarks and registered trademarks

- iPad and iPhone are trademarks of Apple Inc., registered in the U.S. and other countries.
- Android is a trademark of Google LLC.
- ONVIF is a trademark of ONVIF, Inc.
- All other trademarks identified herein are the property of their respective owners.

Important

- Safety Precautions : Carefully read the Basic Information, Installation Guide and Operating Instructions before using this product.
- i-PRO Co., Ltd. cannot be held responsible for the performance of the network and/or other manufacturers' products used on the network.

• Masses and dimensions are approximate. • Specifications are subject to change without notice.