

WV-U65301-Z1

2MP (1080p) 10x Outdoor PTZ Network Camera

U series PTZ camera

U-Series launch gives customers PTZ's that meet top security certifications (FIPS 140-2 level 3) while also providing a unique blend of imaging performance, reliability and affordability.



- 2MP (1080p) 1920x1080
- 10x Optical zoom
- Intelligent Auto
- Super Dynamic 144dB
- Color night vision (0.001 to 0.015 lx)
- Durable Pan/Tilt gear mechanism
- IP66, IK10 certified
- Built-in FIPS 140-2 Level 3 Certified Secure Element with TPM functionality (EdgeLock® SE050F NXP® Semiconductors)
- NDAA Compliant



SPECIFICATIONS

Camera	
Image Sensor	Approx. 1/2.8 type CMOS image sensor
Minimum Illumination	Color : 0.015 lx (50IRE, F1.6, 1/30s) Color : 0.001 lx (50IRE, F1.6, 16/30s) BW : 0.006 lx (50IRE, F1.6, 1/30s) BW : 0.0004 lx (50IRE, F1.6, 16/30s)
White Balance	ATW1 / ATW2 / AWC
Shutter Speed	[60 fps Mode] 1/60 Fix to 1/10000 Fix, [30 fps/15 fps mode] 1/30 Fix to 1/10000 Fix [50 fps Mode] 1/50 Fix to 1/10000 Fix, [25 fps/12.5 fps mode] 1/25 Fix to 1/10000 Fix
Intelligent Auto	On / Off
Super Dynamic	On / Off, the level can be set in the range of 0 to 31.
Dynamic Range	Max.144 dB (Super Dynamic : On, Level 31)
Adaptive Black Stretch	The level can be set in the range of 0 to 255.
Back light compensation / High light compensation	BLC (Back light compensation) / HLC (High light compensation) / Off The level can be set in the range of 0 to 31 (only when Super dynamic / Intelligent Auto : Off)
Fog compensation	On / Off, The level can be set in the range of 0 to 8 (only when Intelligent auto / auto contrast adjust : Off)
Maximum gain (AGC)	The level can be set in the range of 0 to 11.
Color/BW (ICR)	Off / On / Auto1 / Auto2 / Auto3 (SCC)
Digital Noise Reduction	The level can be set in the range of 0 to 255.
Video Motion Detection (VMD)	On / Off, 4 areas available
Scene Change Detection (SCD)	On / Off, 1 areas available
Audio Detection	On / Off
AI Sound Classification	-
AI Analytics	-
Privacy Zone	On / Off, Up to 32 zones available
VIQS	On / Off, Up to 8 zones available
Image Stabilizer	On / Off

Camera Title (OSD)	On / Off, Up to 40 characters (alphanumeric characters, marks)
Focus Adjustment	Auto focus

Lens	
Optical zoom	10x (Motorized zoom / Motorized Focus)
Extra zoom	Max. 15x (10 to 15x : When resolution is 1280 x 720)
Focal Length	4.7 - 47 mm {3/16 inches - 1-27/32 inches}
Angular Field of View	[16 : 9 mode] Horizontal : 6.7° (TELE) - 62° (WIDE), Vertical : 3.8° (TELE) - 37° (WIDE) [4 : 3 mode] Horizontal : 5.1° (TELE) - 48° (WIDE), Vertical : 3.8° (TELE) - 37° (WIDE)
Maximum Aperture Ratio	1 : 1.6 (WIDE) - 1 : 3.0 (TELE)
Focus Range	1.5 m {59-1/16 inches} - ∞

DORI	
Detect (25ppm / 8ppf)	Wide: 64.2m / 210.5 ft, Tele: 656.0 m / 2152.3 ft
Observe (62.5ppm / 19ppf)	Wide: 25.7 m / 84.2 ft, Tele: 262.4 m / 860.9 ft
Recognize (125ppm / 38ppf)	Wide: 12.8 m / 42.1 ft, Tele: 131.2 m / 430.5 ft
Identify (250ppm / 76ppf)	Wide: 6.4m / 21.1 ft, Tele: 65.6 m / 215.2 ft

System on Chip (SoC)	
System on Chip (SoC)	Ambarella CV25M

Adjusting Angle	
Adjusting Angle	Horizontal : 360° Endless Panning, Vertical : -15° to +195°, Yaw : 0°

Pan/tilt	
Panning Range	360° Endless Panning
Panning Speed	Manual: Approx. 0.065°/s - 150°/s , Preset: Up to approx. 500°/s
Tilting Range	Operational -15 - +195°
Tilting Speed	Manual: Approx. 0.065°/s -150°/s Preset: Up to approx. 500°/s (PoE+), Up to approx. 350°/s (DC12 V PoE)
Preset Positions	256 positions

Auto Mode	Auto pan/ Preset sequence/ Patrol
Self Return	10 s/ 20 s/ 30 s/ 1 min/ 2 min/ 3 min/ 5 min/ 10 min/ 20 min/ 30 min/ 60 min

Browser GUI	
Camera Control	Brightness, AUX On / Off
Audio	Mic (Line) Input : On / Off Volume adjustment : Low / Middle / High Audio Output : On / Off Volume adjustment : Low / Middle / High
GUI / Setup Menu Language	English, Italian, French, German, Spanish, Portuguese, Russian, Chinese, Japanese
Browser	Microsoft Edge, Firefox, Google Chrome

Network	
Network IF	10 Base-T / 100 Base-TX, RJ45 connector
Resolution H.265/ H.264 JPEG (MJPEG)	[16 : 9 mode (60 fps mode)] , [16 : 9 mode (30 fps mode)], [16 : 9 mode (50 fps mode)] , [16 : 9 mode (25 fps mode)] 1920x1080, 1280x720, 640x360, 320x180 [4 : 3 mode (30 fps mode)], [4 : 3 mode (25 fps mode)] 1280x960, VGA, QVGA [4 : 3 mode (15 fps mode)], [4 : 3 mode (12.5 fps mode)] 2048x1536 , 1280x960, VGA, QVGA
H.265/H.264	[Transmission Mode] Constant bit rate / VBR / Frame rate / Best effort [Transmission Type] Unicast port (AUTO) / Unicast port (MANUAL) / Multicast
JPEG	[Image Quality] 10 steps
Smart Coding	GOP (Group of pictures) control: Off/ Low (Variable GOP 1s-8s)/ Mid (Variable GOP 4s-16s)/ Advanced(Fixed GOP 60s w/1s key-frame)/ Frame rate control (Variable GOP 4s-16s with frame rate control) *Advanced and Frame rate control are only available with H.265. Smart Coding: Auto VIQS: On/Off
Audio Compression	G.726 (ADPCM) : 16 kbps / 32 kbps , G.711 : 64 kbps , AAC-LC : 64 kbps / 96 kbps / 128 kbps
Audio Transmission Mode	Off / Mic (Line) input / Audio output / Interactive (Half duplex) / Interactive (Full duplex)
Supported Protocol	IPv6 : TCP/IP, UDP/IP, HTTP, HTTPS, SSL/TLS, SMTP, DNS, NTP, SNMPv1/v2/v3, DHCPv6, RTP, MLD, ICMP, ARP, IEEE 802.1X, DiffServ, SFTP, MQTT, LLDP IPv4 : TCP/IP, UDP/IP, HTTP, HTTPS, SSL/TLS, RTSP, RTP, RTP/RTCP, SMTP, DHCP, DNS, DDNS, NTP, NMPv1/v2/v3, UPnP, IGMP, ICMP, ARP, IEEE 802.1X, DiffServ, SRTP, SFTP, MQTT, LLDP, NTCIP

No. of Simultaneous Users	Up to 14 users (Depends on network conditions)
Secure	FIPS 140-2 level 3 Certified Secure Element (NXP® EdgeLock® SE050F), Device Certificate GlobalSign® pre-installed, User authentication, Host authentication, HTTPS, 802.1X Support, Data encryption
SDXC/SDHC/SD Memory Card (Option)	H.265 / H.264 recording : Manual REC / Alarm REC (Pre/Post) / Schedule REC / Backup upon network failure JPEG recording : Manual REC / Alarm REC (Pre/Post) / Backup upon network failure Compatible SDXC/SDHC/SD Memory Card : microSDXC memory card : 64 GB, 128 GB, 256 GB, 512 GB microSDHC memory card : 4 GB, 8 GB, 16 GB, 32 GB microSD memory card : 2 GB
Mobile Terminal Compatibility	iPad, iPhone (iOS 8.0 or later), Android™ terminals
ONVIF® Profile	G / S / T

Alarm

Alarm Source	3 terminals input, VMD alarm, Command alarm, Audio detection alarm
Alarm Actions	SDXC/SDHC/SD memory recording, E-mail notification, HTTP alarm notification Indication on browser, TCP alarm notification output

Input/Output

Audio Input	<p>ø3.5 mm stereo mini jack</p> <p>For microphone input : Recommended applicable microphone : Plug-in power type (Sensitivity of microphone : -51 dB to -38 dB (0 dB=1 V/Pa, 1 kHz))</p> <p>Input impedance : Approx. 2 kΩ (unbalanced)</p> <p>Supply voltage : 2.5 V ±0.5 V</p> <p>For line input : Input level : Approx. -10 dBV</p>
Audio Output	<p>ø3.5 mm stereo mini jack (stereo output)</p> <p>Output impedance : Approx. 600 Ω (unbalanced)</p> <p>Output level : -20 dBV</p>
External I/O Terminals	<p>ALARM IN 1 (Alarm input 1/ Black & white input/ Auto time adjustment input) (x1)</p> <p>ALARM IN 2 (Alarm input 2/ ALARM OUT) (x1), ALARM IN 3 (Alarm input 3/ AUX OUT) (x1)</p>

General

Safety	UL (UL62368-1), c-UL (CSA C22.2 No.62368-1), CE, IEC62368-1
EMC	FCC (Part15 ClassA), ICES-003 Issue 7 ClassA, EN55032 ClassA, EN55035

Power Source and Power Consumption	DC12 V, PoE (IEEE802.3af), PoE+ (IEEE802.3at) DC12 V: 1.3 A / Approx.15.6 W PoE DC 48 V: 270 mA / Approx.12.95 W (Class 0 device) PoE+ DC 54 V: 340 mA / Approx18.4 W(Class 4 device)
Ambient Operating Temperature	-30 °C to +55 °C (-22 °F to +131 °F) (Power On range : -20 °C to +55 °C {-4 °F to +131 °F}) Maximum temperature according to NEMA TS2(2.2.7) : 74 °C(165 °F)
Ambient Operating Humidity	10 to 100 % (no condensation)
Anti-Condensation System	Temish element
Water and Dust Resistance	IP66, IEC60529 measuring standard compatible, Type 4X(UL50E), NEMA 4X compliant
Shock Resistance	IK10 (IEC 62262)
Other standard support	NEMA TS2(2.2.7-2.2.9)
Dimensions	ø165 mm x 139 mm (H) {ø6-1/2 inches x 5-15/32 inches (H)}
Mass (Approx.)	Approx. 1.6 kg {3.53 lbs.}
Finish	Main body : Aluminum die cast, Black polycarbonate resin, i-PRO white Outer fixing screws : Stainless steel (Corrosion-resistant treatment) Dome section : Polycarbonate resin, Clear

NOTES

Important

- Safety Precautions : Carefully read the Basic Information, Installation Guide and Operating Instructions before using this product.
- i-PRO Co., Ltd. cannot be held responsible for the performance of the network and/or other manufacturers' products used on the network.
- Masses and dimensions are approximate.
- Specifications are subject to change without notice.

Trademarks and registered trademarks

- iPad and iPhone are trademarks of Apple Inc., registered in the U.S. and other countries. - Android is a trademark of Google LLC.
- ONVIF is a trademark of ONVIF, Inc.
- All other trademarks identified herein are the property of their respective owners

©i-PRO Co., Ltd All rights reserved / November 2022

OPTIONAL ACCESSORIES

Select a compatible accessory

[Accessory Selector \(i-pro.com\)](http://i-pro.com).



WV-QDC502G
Dome Cover



WV-QWL501-W
Mount Bracket



WV-QSR501-W
Mount Bracket



WV-QWL500-W
Mount Bracket



WV-QJB500-W
Mount Bracket



WV-QSR501F1-W
Mount Bracket



WV-QCL501-W
Mount Bracket



WV-QSR501M1-W
Mount Bracket



WV-QJB501-W
Base Bracket



WV-QEM503-W
Ceiling Mount Bracket



WV-QJB504-W
Base Bracket



WV-QSR501F-W
Mount Bracket



WV-QSR501M-W
Mount Bracket



WV-QCA501A
I/O Cable

APPEARANCE

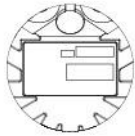

Object model: WV-B65301-Z1

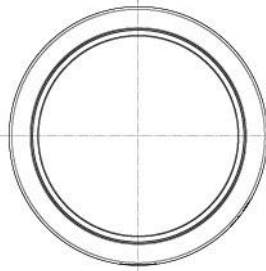
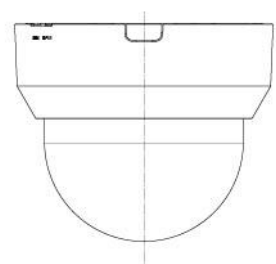
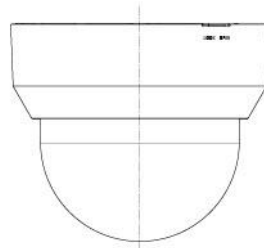
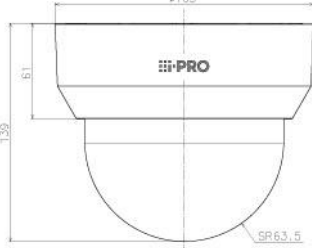
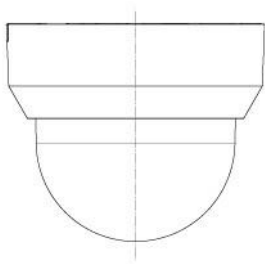
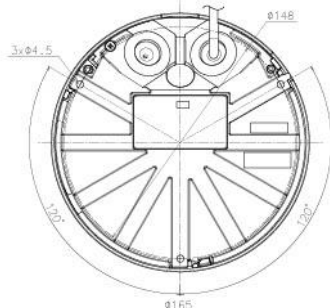

Model number	Dome type
WV-U65301-Z1	Clear dome
WV-U65301-Z1G	Smoke dome
WV-B65301-Z1	Clear dome

	投影面積 / Projected area
側面圖 / Side-view	0.018 (m ²)

Mass : Approx. 1.3 kg (2.87 lbs)